

各式螺絲種類及適用規格

■ Relations Between Screwdriver and Screw

Slotted			Philips			Pozidriv			T			Special Point Sizes, Lengths, End Types Available on Request			
Machine Screw	Wood Screw		Machine Screw	Tapping Screw		Machine Screw	Tapping Screw		Bolt	Tapping Screw	Self-tapping Screw				
18 x 0.25	1.0 1.2		No.0			2	2.2	2.1				T5	2.5		
2.5 x 0.35	1.6	1.8				2.2	2.5	2.9				T6	3		
3 x 0.45	2	2.1	No.1	SDV No.1 PZD No.1		2.2	2.9	3.0	2.5	2	4	T8	2.5	2	4
4 x 0.6	2.2 2.6	2.4	No.2	SDV No.2 PZD No.2		3.5	4	4	3	2.9	5	T10	3	2.9	5
4.5 x 0.6	3	2.7 3.1	No.3	SDV No.3 PZD No.3		4	4.5	4.8	4	4.8	5	T15	3.5	3.5	
5.0 x 0.8	3.5	3.5				5	4.2	4.5	4	3.9	6	T20	4	3.9	6
5.5 x 1.0	4	3.8	No.4			6	5.5	6.3	5	4.2		T25	5	4.2	
6 x 1.2	5	4.5				8	7	8	6	4.8	8	T27	6	4.8 5.5	
7 x 1.2	6	4.8 5				10	8	7	8	6.3	10	T30	6		
8 x 1.6	8	5.5 5.8							8	8	12	T40	8	6.3	10
9 x 1.6	8	6.2 6.8							8	8	12	T45	8	8	12
10 x 1.6	8	7.5 8							10	10	14	T50	10	10	14
12 x 2.0	8	8							12	12	16 18	T55	12	12	16 18
									14	14		T60	14	14	

CONVERSION TABLE INCHES/MILLIMETERS

inches Millimeters inches Millimeters inches Millimeters inches Millimeters

1/64	0.397	33/64	13.097	17/64	6.747	49/64	19.447
1/32	0.794	17/32	13.494	9/32	7.144	25/32	19.844
3/64	1.191	35/64	13.891	19/64	7.541	51/64	20.241
1/16	1.588	9/16	14.288	5/16	7.938	13/16	20.638
5/64	1.984	37/64	14.684	21/32	8.334	53/64	21.034
3/32	2.381	19/32	15.081	11/32	8.731	27/32	21.431
7/64	2.778	39/64	15.478	23/64	9.128	55/64	21.828
1/8	3.175	5/8	15.875	3/8	9.525	7/8	22.225
9/64	3.572	41/64	16.262	25/64	9.922	57/64	22.622
5/32	3.969	21/32	16.669	13/32	10.319	29/32	23.019
11/64	4.366	43/64	17.066	27/64	10.716	59/64	23.416
3/16	4.762	11/16	17.462	7/16	11.112	15/16	23.812
13/64	5.159	45/64	17.859	29/64	11.509	61/64	24.202
7/32	5.556	23/32	18.256	15/32	11.906	31/32	24.606
15/64	5.963	47/64	18.653	31/64	12.303	63/64	25.003
1/4	6.350	3/4	19.050	1/2	12.700	1	25.400

1 mm = .3937"

.001" = .254 mm

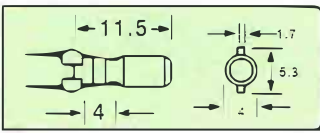

M-3 ϕ 4mm 各式十字、一字、梅花起子頭

ϕ 4mm SHANK DRIVE

● FOR: AEROMAX, DENSI, HIOS



PHILLIPS

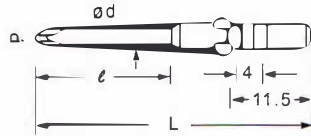

Model No.

P x d x ℓ x L

PH001240E4	00 x 1.2 x 20 x 40
PH001260E4	00 x 1.2 x 20 x 60
PH001540E4	00 x 1.5 x 20 x 40
PH001560E4	00 x 1.5 x 20 x 60
PH001740E4	00 x 1.7 x 20 x 40
PH001760E4	00 x 1.7 x 20 x 60
PH002040E4	00 x 2.0 x 20 x 40
PH002060E4	00 x 2.0 x 20 x 60
PH02540E4	0 x 2.5 x 20 x 40
PH02560E4	0 x 2.5 x 20 x 60
PH02560E4	0 x 2.5 x 20 x 80
PH025100E4	0 x 2.5 x 20 x 100
PH0253100E4	0 x 2.5 x 30 x 100
PH12540E4	1 x 2.5 x 20 x 40
PH13040E4	1 x 3.0 x 20 x 40
PH13060E4	1 x 3.0 x 20 x 60
PH13080E4	1 x 3.0 x 20 x 80
PH130100E4	1 x 3.0 x 20 x 100
PH14040E4	1 x 4.0 x 40
PH14060E4	1 x 4.0 x 60
PH14080E4	1 x 4.0 x 80
PH140100E4	1 x 4.0 x 100
PH23040E4	2 x 3.0 x 20 x 100
PH24040E4	2 x 4.0 x 40
PH24060E4	2 x 4.0 x 60
PH24080E4	2 x 4.0 x 80
PH240100E4	2 x 4.0 x 100
PH240120E4	2 x 4.0 x 120



SLOTTED



w x t x ℓ x L

SL112840E4	1.1 x 0.28 x 20 x 40
SL153040E4	1.5 x 0.30 x 20 x 40
SL173040E4	1.7 x 0.30 x 20 x 40
SL184040E4	1.8 x 0.40 x 20 x 40
SL204040E4	2.0 x 0.40 x 20 x 40
SL254040E4	2.5 x 0.40 x 20 x 40
SL304040E4	3.0 x 0.40 x 20 x 40
SL406040E4	4.0 x 0.60 x 20 x 40



T (H = Tamper Proof)



T x d x ℓ x L

TX52040E4	5 x 2.0 x 20 x 40
TX52060E4	5 x 2.0 x 20 x 60
TX62040E4	6 x 2.0 x 20 x 40
TX62060E4	6 x 2.0 x 20 x 60
TX64060E4	6 x 4.0 x 60
TX52040E4	7 x 2.0 x 20 x 60
TX74060E4	7 x 4.0 x 60
TX8H4060E4	8H x 4.0 x 60
TX9H4060E4	9H x 4.0 x 60
TX9H4060E4	10H x 4.0 x 60
TX15H4060E4	15H x 4.0 x 60

OTHER LENGTHS OR TYPES AVAILABLE ON REQUEST.

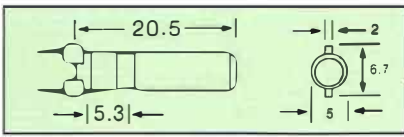

M-6 ϕ 5mm 各式十字、一字、梅花及特殊起子頭

Ø5mm SHANK DRIVE

● FOR: AEROMAX, DENSI, HIOS

PHILLIPS		Model No.	P x d x ℓ x L
		PH002060E5	00 x 2.0 x 20 x 60
		PH02560E5	0 x 2.5 x 25 x 60
		PH12660E5	1 x 2.6 x 25 x 60
		PH12680E5	1 x 2.6 x 25 x 80
		PH126100E5	1 x 2.6 x 25 x 100
		PH13060E5	1 x 3.0 x 25 x 60
		PH13080E5	1 x 3.0 x 25 x 80
		PH130100E5	1 x 3.0 x 25 x 100
		PH15060E5	1 x 5.0 x 60
		PH15080E5	1 x 5.0 x 80
		PH150100E5	1 x 5.0 x 100
		PH150120E5	1 x 5.0 x 120
		PH150150E5	1 x 5.0 x 150
		PH25060E5	2 x 5.0 x 60
		PH25080E5	2 x 5.0 x 80
		PH250100E5	2 x 5.0 x 100
	PH250120E5	2 x 5.0 x 120	
	PH250150E5	2 x 5.0 x 150	
T (H = Tamper Proof)			T x d x ℓ x L
		TX55060E5	5 x 5 x 60
		TX65060E5	6 x 5 x 60
		TX75060E5	7 x 5 x 60
		TX8H5060E5	8H x 5 x 60
		TX9H5060E5	9H x 5 x 60
		TX10H5060E5	10H x 5 x 60
		TX15H5060E5	15H x 5 x 60
SLOTTED			w x t x ℓ x L
		SL203060E5	2 x 0.3 x 25 x 60
		SL254060E5	2.5 x 0.4 x 25 x 60
		SL304060E5	3 x 0.4 x 25 x 60
		SL406060E5	4 x 0.6 x 25 x 60
		SL507560E5	5 x 0.75 x 25 x 60
TRIANGLE			T x L
		TA1860E5	TA18 x 60
		TA2060E5	TA20 x 60
		TA2860E5	TA23 x 60
		TA2760E5	TA27 x 60
TRI-WING			P x L
		TW060E5	0 x 60
		TW160E5	1 x 60
		TW260E5	2 x 60
		TW360E5	3 x 60
		TW460E5	4 x 60
		TW560E5	5 x 60
SPANNER			P x L
		SP4560E5	4.5 x 60
		SP5060E5	5 x 60
		SP6060E5	6 x 60

OTHER LENGTHS OR TYPES AVAILABLE ON REQUEST.

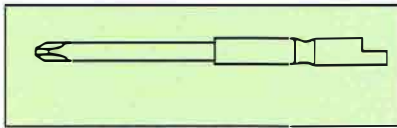

φ 4mm 半圓各式十字、一字、梅花起子頭

Ø4mm DRIVE

● FOR: DENSEI



PHILLIPS

Model No.

P x d x ℓ x L



PH002044D4	00 x 2.0 x 20 x 44
PH02544D4	0 x 2.5 x 20 x 44
PH13044D4	1 x 3.0 x 20 x 44
PH14044D4	1 x 4.0 x 20 x 44
PH24044D4	2 x 4.0 x 20 x 44



SLOTTED

w x t x ℓ x L



SL304044D4	3 x 0.4 x 20 x 44
SL405044D4	4 x 0.5 x 20 x 44



HEXAGON HEAD

H x L



HX1544D4	1.5 x 44
HX2044D4	2.0 x 44
HX2544D4	2.5 x 44
HX3044D4	3.0 x 44



T (H = Tamper Proof)

T x L



TX544D4	5.0 x 44
TX644D4	6.0 x 44
TX8H44D4	8H x 44
TH10H44D4	10H x 44
TX15H44D4	15H x 44

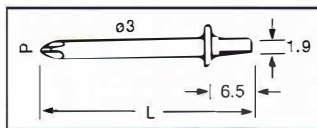

特殊訂製品起子頭



Ø3mm DRIVE

● FOR: VESSEL



PHILLIPS

P x L (Heat Treatment)



PH036C3	0 x 36H
PH136C3	1 x 36H
PH170C3	1 x 70H
PH1100C3	1 x 100H

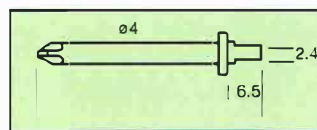

特殊訂製品起子頭



Ø4mm DRIVE

● FOR: VESSEL



PHILLIPS

P x L (Heat Treatment)



PH036C4	0 x 36H
PH136C4	1 x 36H
PH170C4	1 x 70H
PH1100C4	1 x 100H

OTHER LENGTHS OR TYPES AVAILABLE ON REQUEST.

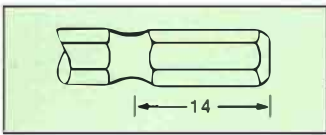

US-4 對邊5mm十字、一字、內六角、梅花起子頭

5mm HEX DRIVE

● FOR: AEROMAX, DENSEI, HIOS, HITACHI, MATSUSHITA, URYU, YOKOTA

PHILLIPS		Model No.	P x d x ℓ x L
		PH02570A1	0 x 2.5 x 30 x 70
		PH13070A1	1 x 3.0 x 30 x 70
		PH14070A1	1 x 4.0 x 30 x 70
		PH140110A1	1 x 4.0 x 30 x 110
		PH16050A1	1 x 6.0 x 50
		PH160100A1	1 x 6.0 x 100
		PH160125A1	1 x 6.0 x 125
		PH23070A1	2 x 3.0 x 30 x 70
		PH25070A1	2 x 5.0 x 30 x 70
		PH250110A1	2 x 5.0 x 30 x 110
		PH26050A1	2 x 6.0 x 50
		PH260100A1	2 x 6.0 x 100
		PH260125A1	2 x 6.0 x 125
		PH260150A1	2 x 6.0 x 150
		PH260200A1	2 x 6.0 x 200
	PH36070A1	3 x 6.0 x 70	

T (H = Tamper Proof)		T x d x ℓ x L	
		TX67075A1	6 x 2.0 x 30 x 75
		TX72075A1	7 x 2.0 x 30 x 75
		TX82575A1	8 x 2.5 x 30 x 75
		TX92575A1	9 x 2.5 x 30 x 75
		TX103075A1	10 x 3.0 x 30 x 75
		TX153575A1	15 x 3.5 x 30 x 75
		TX205075A1	20 x 5.0 x 30 x 75
		TX255075A1	25 x 5.0 x 30 x 75
		TX275075A1	27 x 5.0 x 30 x 75

HEXAGON HEAD		H x D x L	
		HX2070A1	2 x 6 x 70
		HX2570A1	2.5 x 6 x 70
		HX3070A1	3 x 6 x 70
		HX4070A1	4 x 6 x 70
		HX5070A1	5 x 6 x 70

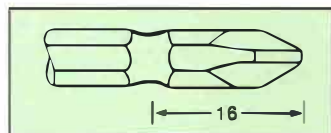

5mm DOUBLE END HEX DRIVE

● FOR: DENSEI, HITACHI, HIOS, MATSUSHITA, URYU, YOKOTA

PHILLIPS		P x L (Heat Treatment)	
		PH170A2	1 x 70H
		PH1100A2	1 x 100H
		PH270A2	2 x 70H
		PH2100A2	2 x 100H
		PH2150A2	2 x 150H
		PH2200A2	2 x 200H
		PH2260A2	2 x 250H
		PH2300A2	2 x 300H

OTHER LENGTHS OR TYPES AVAILABLE ON REQUEST.

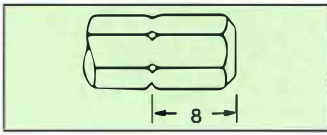

US-5對邊6.35mm短頭各式起子頭

1/4" = 6.35mm HEX SHANK

● FOR: 1/4" HEX OPENING BIT HOLDERS



PHILLIPS

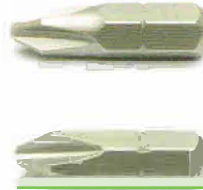
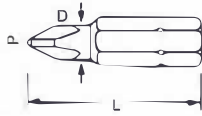

Model No. P x D x L

PH025416	0 x 3.0 x 1" (25.4mm)
PH125416	1 x 4.5 x 1" (25.4mm)
PH225416	2 x 6.0 x 1" (25.4mm)
PH325416	3 x 6.0 x 1" (25.4mm)
PH238116	2 x 1-1/2" (38.1mm)
PH14916	1 x 1-5/16" (49mm)
PH24916	2 x 1-5/16" (49mm)
PH34916	3 x 1-5/16" (49mm)
PH263516	2 x 2-1/2" (63.5mm)



POZIDRIV



P x L

PZ125416	1 x 1" (25.4mm)
PZ225416	2 x 1" (25.4mm)
PZ325416	3 x 1" (25.4mm)
PZ14916	1 x 1-5/16" (49mm)
PZ24916	2 x 1-5/16" (49mm)
PZ34916	3 x 1-5/16" (49mm)



SLOTTED

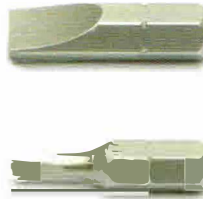
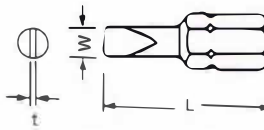

w x t x L

SL30502516	3.0 x 0.5 x 25
SL35552516	3.5 x 0.55 x 25
SL40602516	4.0 x 0.6 x 25
SL45702516	4.5 x 0.7 x 25
SL50752516	5.0 x 0.75 x 25
SL55802516	5.5 x 0.8 x 25
SL60852516	6.0 x 0.85 x 25
SL65852516	6.5 x 0.85 x 25
SL70902516	7.0 x 0.9 x 25
SL75952516	7.5 x 0.95 x 25
SL801002516	8.0 x 1.0 x 25



HEXAGON

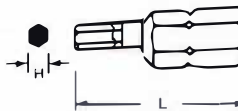

H x L

HX3125416	1/8" x 1" (25.4mm)
HX3525416	9/64" x 1" (25.4mm)
HX394916	5.32" x 1-5/16" (49mm)
HX474916	3.16" x 1-5/16" (49mm)
HX554916	7.32" x 1-5/16" (49mm)
HX634916	1/4" x 1-5/16" (49mm)
HX202516	2.0 x 25
HX252516	2.5 x 25
HX302516	3.0 x 25



SQUARE RECESS



P (Size) x L

SQ025416	0 (1/16") x 1"
SQ125416	1 (3/32") x 1"
SQ225416	2 (1/8") x 1"
SQ325416	3 (9/64") x 1"

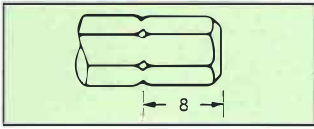

US-5對邊6.35mm短頭各式起子頭

1/4" = 6.35mm HEX SHANK

● FOR: 1/4" HEX OPENING BIT HOLDERS



TORO-SET



Model No.	P x L
TS12516	1 x 1"
TS22516	2 x 1"
TS32516	3 x 1"
TS42516	4 x 1"



T (H = Tamper Proof)

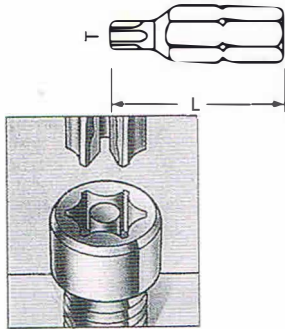

T x L	
TX62516	6 x 25
TX72516	7 x 25
TX82516	8 x 25
TX92516	9 x 25
TX102516	10 x 25
TX152516	15 x 25
TX202516	20 x 25
TX252516	25 x 25
TX272516	27 x 25
TX302516	30 x 25
TX402516	40 x 25
TX8H2516	8H x 25
TX9H2516	9H x 25
TX10H2516	10H x 25
TX15H2516	15H x 25
TX20H2516	20H x 25
TX25H2516	25H x 25
TX27H2516	27H x 25
TX30H2516	30H x 25
TX40H2516	40H x 25

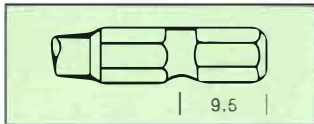

1/4" = 6.35mm HEX BIT HOLDER

- FOR: AEROMAX, AET, ARO, ATLAS-COPCO, BIAx, B & D, BOSCH, BUCKEY-TOOLS, CHICAGO-PNEUMATIC, CLECO, DELCO, DELVO (DENSEI), DEPRAG, DESOUTTER, FIAM, FUJI-KUKI, GARDNER-DENVER, HIOS (FERRA TOOLS), HITACHI, INGERSOLL, KELLER, MAKITA, MALL, MATSUSHITA, METABO, NPK, PNEUTEC, PREMAG, ROCKWELL, ROTOR-TOOL, SKIL, STANLEY, STAR, STAYER, THOR, TONICHI, URYU, VAN-DORN, VIRAX, WOLF, YOKOTA, YUTANI

FOR 1/4" HEX INSERT BITS

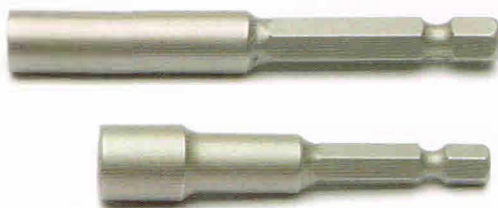

Model No.	O. A. L
BH654BI	2-1/8" (54mm)
BH6102BI	4" (102mm)
BH6152BI	6" (152mm)
BH6203BI	8" (203mm)
BH6254BI	10" (254mm)
BH6305BI	12" (305mm)
BH650D8	50mm
BH676D8	76mm

OTHER LENGTHS OR TYPES AVAILABLE ON REQUEST.

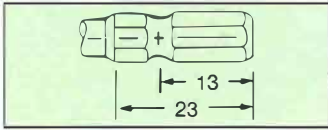

US-5對邊6.35mm雙頭十字起子頭及各式起子頭 1/4" = 6.35mm HEX DRIVE

● FOR: HITACHI, MAKITA, MATSUSHITA, MAX, NPK, RYOBI, TONICHI, TOSHIBA, VESSEL, YOKOTA, YUTANI

 PHILLIPS (M= MAGNETIC)		Model No.	P x D x L
  		PH14565F1	1 x 4.5 x 65H
		PH24565F1	2 x 4.5 x 65H
		PH245100F1	2 x 4.5 x 100H
		PH245150F1	2 x 4.5 x 6.3 x 150H
		PH25082F1	2 x 5.0 x 6.0 x 82E
		PH35082F1	3 x 5.0 x 6.0 x 82E
 SLOTTED		W x T x L (Heat Treatment)	
		SL608045F1	6 x 0.8 x 45G
		SL608070F1	6 x 0.8 x 70G
		SL810045F1	8 x 1.0 x 45G
		SL810070F1	8 x 1.0 x 70G
		SL1012052F1	10 x 1.2 x 52G
		SL1012070F1	10 x 1.2 x 70G
 HEXAGON HEAD = (METRIC)		H x L (Heat Treatment)	
		HX2065F1	2 x 65H
		HX2565F1	2.5 x 65H
		HX3065F1	3 x 65H
		HX4065F1	4 x 65H
		HX5065F1	5 x 65H
		HX6065F1	6 x 65H
		HX20 110F1	2 x 110H
		HX25 110F1	2.5 x 110H
		HX30 110F1	3 x 110H
		HX40 110F1	4 x 110H
		HX50 110F1	5 x 110H
		HX60 110F1	6 x 110H
 T		T x D x L	
		TX104565F1	10 x 4.5 x 65
		TX154565F1	15 x 4.5 x 65
		TX204565F1	20 x 5.0 x 65
		TX254565F1	25 x 5.0 x 65
		TX274565F1	27 x 5.5 x 65
		TX304565F1	30 x 6.0 x 65
		TX404565F1	40 x 7.0 x 65

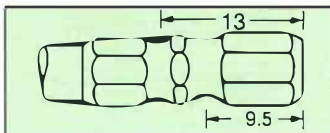

1/4" = 6.35mm HEX DRIVE (DOUBLE GROOVE, MAGNETIC TYPE)

● FOR: VARIOUS TYPES OF POWER TOOLS

 PHILLIPS		Model No.	P x D1 x D2 x L
		PH24565F3	2 x 4.5 x 65H
		PH245100F3	2 x 4.5 x 100H
		PH245150F3	2 x 4.5 x 6.3 x 150H

OTHER LENGTHS OR TYPES AVAILABLE ON REQUEST.

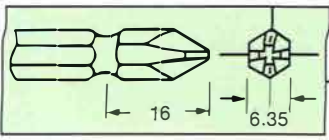

US-5對邊6.35mm雙頭十字起子頭及各式起子頭

1/4" = 6.35mm HEX DRIVE

● FOR: MAKITA, MATSUSHITA, MAX, NITTO-KOKI, NPK, PYOBI, TONICHI, TOHSHIBA, VESSEL, YUTANI



PHILLIPS



Model No.

P x L (Heat Treatment)



PH145HF2	1 x 45H
PH165HF2	1 x 65H
PH165GF2	1 x 65G
PH1110HF2	1 x 110H
PH1110GF2	1 x 110G
PH245HF2	2 x 45H
PH245GF2	2 x 45G
PH265HF2	2 x 65H
PH265GF2	2 x 65G
PH265EF2	2 x 65E
PH2110HF2	2 x 110H
PH2110GF2	2 x 110G
PH2110EF2	2 x 110E
PH2150HF2	2 x 150H
PH2150GF2	2 x 150G
PH2150EF2	2 x 150E
PH2200HF2	2 x 200H
PH2200GF2	2 x 200G
PH2200EF2	2 x 200E
PH2300GF2	2 x 300G
PH345HF2	3 x 45H
PH345EF2	3 x 45E
PH365HF2	3 x 65H
PH365EF2	3 x 65E
PH3110HF2	3 x 110H
PH3110EF2	3 x 110E

(SUPER HEAVY DUTY TYPE)

P x L

PH250SF2	2 x 50S
PH275SF2	2 x 75S
PH2100SF2	2 x 100S
PH2150SF2	2 x 150S



POZIDRIV



P x L (Heat Treatment)



PZ165F2	1 x 65H
PZ245F2	2 x 45H
PZ265F2	2 x 65H
PZ2110F2	2 x 110H
PZ365F2	3 x 65H

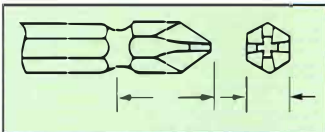

5/16" = 8mm HEX DRIVE

● FOR: HITACHI, MATSUSHITA, VESSEL



PHILLIPS



Model No.

P x L (Heat Treatment)



PH365G2	3 x 65E
PH465G2	4 x 65E

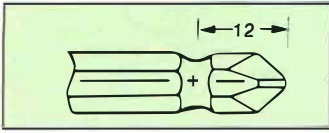

OTHER LENGTHS OR TYPES AVAILABLE ON REQUEST.





US-5對邊6.35mm雙頭十字起子頭及各式起子頭

1/4" = 6.35mm HEX DRIVE

● FOR: AEROMAX, FUJI, HITACHI, MAKITA, NPK, TONICHI, URYU, YOKOTA, YUTAN

 PHILLIPS		Model No.	P x L (Heat Treatment)
 		PH150HB2	1 x 50H
		PH175HB2	1 x 75H
		PH1100HB2	1 x 100H
		PH1150HB2	1 x 150H
		PH250HB2	2 x 50H
		PH275HB2	2 x 75H
		PH275GB2	2 x 75G
		PH275EB2	2 x 75E
		PH2100HB2	2 x 100H
		PH2100GB2	2 x 100G
		PH2100EB2	2 x 100E
		PH2150GB2	2 x 150G
		PH2200GB2	2 x 200G
		PH2300HB2	2 x 300H
		PH375HB2	3 x 75H
		PH375EB2	3 x 75E
PH3100HB2	3 x 100H		
PH3100EB2	3 x 100E		

 POZIDRIV 		P x L	
		PZ145B2	1 x 45
		PZ175B2	1 x 75
		PZ245B2	2 x 45
		PZ275B2	2 x 75

 SQUARE RECESS 		P (Size) x L	
		SQ150B2	1 (3/82") x 50
		SQ175B2	1 (3/82") x 75
		SQ1100B2	1 (3/82") x 100
		SQ250B2	2 (1/8") x 50
		SQ275B2	2 (1/8") x 75
		SQ2100B2	2 (1/8") x 100
		SQ2150B2	2 (1/8") x 150
		SQ350B2	3 (9/64") x 50
		SQ375B2	3 (9/64") x 175
		SQ3100B2	3 (9/64") x 100

 COMBINATION 		P x w x L	
 		PH1SL4545B2	1 x 4.5 x 45
		PH1SL4575B2	1 x 4.5 x 75
		PH2SL6045B2	2 x 6.0 x 45
		PH2SL6075B2	2 x 6.0 x 75

OTHER LENGTHS OR TYPES AVAILABLE ON REQUEST.

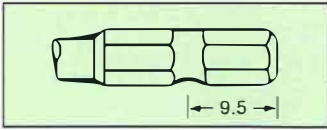

US-5對邊6.35mm十字起子頭

1/4" = 6.35mm HEX DRIVE

- FOR: AEROMAX, AET, ARO, ATLAS-COPCO, BIAx, B & D, BOSCH, BUCKEYE-TOOLS, CHICAGO-PNEUMATIC, CLECO, DELCO, DELVO (DENSEI), DEPRAG, DESOUTTER, FIAM, FUJI-KUKI, GARDNER-DENVER, HIOS (FERRA TOOLS), HITACHI, INGERSOLL, KELLER, MAKITA, MALL, MATSUSHITA, METABO, NPK, PNEUTEC, PREMAG, ROCKWELL, ROTOR-TOOL, SKIL, STANLEY, STAR, STAYER, THOR, TONICHI, URYU, VAN-DORN, VIRAX, WOLF, YOKOTA, YUTANI



PHILLIPS

Model No.

P x D x L



PH001549B1	00 x 1/16" x 1-15/16" (49mm)
PH03149B1	0 x 1/8" x 1-15/16" (49mm)
PH14749B1	1 x 3/16" x 1-15/16" (49mm)
PH24749B1	2 x 3/16" x 1-15/16" (49mm)
PH26349B1	2 x 1/4" x 1-15/16" (49mm)
PH37949B1	3 x 5/16" x 1-15/16" (49mm)
PH03170B1	0 x 1/8" x 2-3/4" (70mm)
PH14770B1	1 x 3/16" x 2-3/4" (70mm)
PH26370B1	2 x 1/4" x 2-3/4" (70mm)
PH37970B1	3 x 5/16" x 2-3/4" (70mm)
PH03189B1	0 x 1/8" x 3-1/2" (89mm)
PH14789B1	1 x 3/16" x 3-1/2" (89mm)
PH26389B1	2 x 1/4" x 3-1/2" (89mm)
PH37989B1	3 x 5/16" x 3-1/2" (89mm)
PH263110B1	2 x 1/4" x (110mm)
PH263127B1	2 x 1/4" x (127mm)
PH147152B1	1 x (3/16" x 2") x 6" (152mm)
PH263152B1	2 x (1/4" x 2") x 6" (152mm)
PH363152B1	3 x (1/4" x 2") x 6" (152mm)
PH001550B1	00 x 1.5 x 50H
PH03050B1	0 x 3.0 x 50H
PH14550B1	1 x 4.5 x 50H
PH24550B1	2 x 4.5 x 50H
PH26050B1	2 x 6.0 x 50H
PH03075B1	0 x 3.0 x 75G
PH14575B1	1 x 4.5 x 75H
PH24575B1	2 x 4.5 x 75H
PH26075B1	2 x 6.0 x 75H
PH36075B1	3 x 6.0 x 75H
PH145100B1	1 x 4.5 x 100H
PH245100B1	2 x 4.5 x 100H
PH260100B1	2 x 6.0 x 100H
PH360100B1	3 x 6.0 x 100H
PH145150B1	1 x 4.5 x 150H
PH245150B1	2 x 4.5 x 150H
PH260150B1	2 x 6.0 x 150H
PH260200B1	2 x 6.0 x 200H

(HEX SHANK TYPE)

P x L (Heat Treatment)



PH123B1	1 x 23H
PH223B1	2 x 23H
PH240B1	2 x 40H
PH2100B1	2 x 100H

OTHER LENGTHS OR TYPES AVAILABLE ON REQUEST.



US-5 對邊6.35mm米字起子頭、一字起子頭

1/4" = 6.35mm HEX DRIVE

- FOR: AEROMAX, AET, ARO, ATLAS-COPCO, BIAx, B&D, BOSCH, BUCKEYE-TOOLS, CHICAGO-PNEUMATIC, CLECO, DELCO, DELVO (DENSEI), DEPRAG, DESOUTTER, FIAM, FUJI-KUKI, GARDNER-DENVER, HIOS (FERRA TOOLS), HITACHI, INGERSOLL, KELLER, MAKITA, MALL, MATSUSHITA, METABO, NPK, PNEUTEC, PREMAG, ROCKWELL, ROTOR-TOOL, SKIL, STANLEY, STAR, STAYER, THOR, TONICHI, URYU, VAN-DORN, VIRAX, WOLF, YOKOTA, YUTANI



POZIDRIV

Model No.

P x D x L

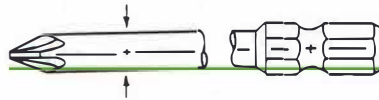

PZ14749B1	1 x 3/16" x 1-15/16" (49mm)
PZ26349B1	2 x 1/4" x 1-15/16" (49mm)
PZ37949B1	3 x 5/16" x 1-15/16" (49mm)
PZ14770B1	1 x 3/16" x 2-3/4" (70mm)
PZ26370B1	2 x 1/4" x 2-3/4" (70mm)
PZ37970B1	3 x 5/16" x 2-3/4" (70mm)
PZ14789B1	1 x 3/16" x 3-1/2" (89mm)
PZ26389B1	2 x 1/4" x 3-1/2" (89mm)
PZ37989B1	3 x 5/16" x 3-1/2" (89mm)
PZ263110B1	2 x 1/4" x (110mm)
PZ263127B1	2 x 1/4" x (127mm)
PZ147152B1	1 x (3/16" x 2") x 6" (152mm)
PZ263152B1	2 x (1/4" x 2") x 6" (152mm)
PZ379152B1	3 x (5/16" x 2") x 6" (152mm)
PZ03050B1	0 x 3.0 x 50
PZ14550B1	1 x 4.5 x 50
PZ26050B1	2 x 6.0 x 50
PZ36050B1	3 x 6.0 x 50
PZ46050B1	4 x 6.0 x 50
PZ03075B1	0 x 3.0 x 75
PZ14575B1	1 x 4.5 x 75
PZ26075B1	2 x 6.0 x 75
PZ36075B1	3 x 6.0 x 75
PZ46075B1	4 x 6.0 x 75
PZ145100B1	1 x 4.5 x 100
PZ260100B1	2 x 6.0 x 100
PZ360100B1	3 x 6.0 x 100
PZ260150B1	2 x 6.0 x 150
PZ260200B1	2 x 6.0 x 200



SLOTTED

w x t x L

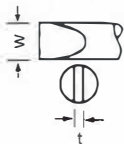

SL305050B1	3.0 x 0.5 x 50
SL355550B1	3.5 x 0.55 x 50
SL406050B1	4.0 x 0.6 x 50
SL457050B1	4.5 x 0.7 x 50
SL507550B1	5.0 x 0.75 x 50
SL558050B1	5.5 x 0.8 x 50
SL608550B1	6.0 x 0.85 x 50
SL658550B1	6.5 x 0.85 x 50
SL709050B1	7.0 x 0.9 x 50
SL8010050B1	8.0 x 1.0 x 50
SL9011550B1	9.0 x 1.15 x 50
SL10012050B1	10 x 1.2 x 50

OTHER LENGTHS OR TYPES AVAILABLE ON REQUEST.

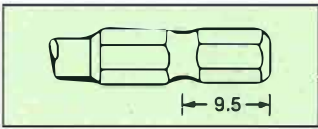

US-5對邊6.35mm內六角起子頭

1/4" = 6.35mm HEX DRIVE

- FOR: AEROMAX, AET, ARO, ATLAS-COPCO, BIAx, B & D, BOSCH, BUCKEYE-TOOLS, CHICAGO-PNEUMATIC, CLECO, DELCO, DELVO (DENSEI), DEPRAG, DESOUTTER, FIAM, FUJI-KUKI, GARDNER-DENVER, HIOS (FERRA TOOLS), HITACHI, INGERSOLL, KELLER, MAKITA, MALL, MATSUSHITA, METABO, NPK, PNEUTEC, PREMAG, ROCKWELL, ROTOR-TOOL, SKIL, STANLEY, STAR, STAYER, THOR, TONICHI, URYU, VAN-DORN, VIRAX, WOLF, YOKOTA, YUTANI



HEXAGON HEAD (ALLEN HEAD)



Model No.

H x D x L

HX253549B1	2.5 x 3.5 x 1-15/16" (49mm)
HX303549B1	3 x 3.5 x 1-15/16" (49mm)
HX404549B1	4 x 4.6 x 1-15/16" (49mm)
HX505849B1	5 x 5.8 x 1-15/16" (49mm)
HX606049B1	6 x 1-15/16" (49mm)
HX207070B1	2 x 7 x 70
HX307070B1	3 x 7 x 70
HX407070B1	4 x 7 x 70
HX507070B1	5 x 7 x 70
HX607070B1	6 x 7 x 70
HX707070B1	7 x 10 x 70
HX807070B1	8 x 11 x 70
HX907070B1	9 x 11 x 70
HX1007070B1	10 x 12 x 70
HX2070100B1	2 x 7 x 100
HX2570100B1	2.5 x 7 x 100
HX3070100B1	3 x 7 x 100
HX4070100B1	4 x 7 x 100
HX5070100B1	5 x 7 x 100
HX6070100B1	6 x 7 x 100



SQUARE RECESS



P (Size) x L

SQ149B1	1 (3/32") x 1-15/16" (49mm)
SQ249B1	2 (1/8") x 1-15/16" (49mm)
SQ349B1	3 (9/64") x 1-15/16" (49mm)
SQ170B1	1 (3/32") x 2-3/4" (70mm)
SQ270B1	2 (1/8") x 2-3/4" (70mm)
SQ370B1	3 (9/64") x 2-3/4" (70mm)
SQ190B1	1 (3/32") x 3-1/2" (90mm)
SQ290B1	2 (1/8") x 3-1/2" (90mm)
SQ390B1	3 (9/64") x 3-1/2" (90mm)
SQ1152B1	1 (3/32") x 6" (152mm)
SQ2152B1	2 (1/8") x 6" (152mm)
SQ3152B1	3 (9/64") x 6" (152mm)

OTHER LENGTHS OR TYPES AVAILABLE ON REQUEST.

MAG-O-NETS®

Detachable Magnetic Rings
for Screwdriver Bits

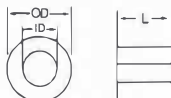

Part No.	Inner Diameter (ID)	Outer Diameter	Length (mm)
AM1/4	7mm	17.5mm	10mm
AM5	6mm	15.0mm	10mm
AM3/16	3/16"	15.0mm	10mm

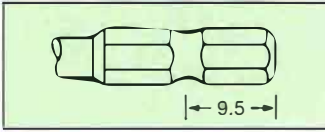

US-5對邊6.35mm梅花起子頭、特殊起子頭



1/4" = 6.35mm HEX DRIVE

- FOR: AEROMAX, AET, ARO, ATLAS-COPCO, BIAx, B & D, BOSCH, BUCKEYE-TOOLS, CHICAGO-PNEUMATIC, CLECO, DELCO, DELVO (DENSEI), DEPRAG, DESOUTTER, FIAM, FUJI-KUKI, GARDNER-DENVER, HIOS (FERRA TOOLS), HITACHI, INGERSOLL, KELLER, MAKITA, MALL, MATSUSHITA, MET ABO, NPK, PNEUTEC, PREMAG, ROCKWELL, ROTOR-TOOL, SKIL, STANLEY, STAR, STAYER, THOR, TONICHI, URYU, VAN-DORN, VIRAX, WOLF, YOKOTA, YUTANI

 T	Model No.	T x D x L
	TX53075B1	5 x 3.0 x 75
	TX64075B1	6 x 4.0 x 75
	TX74075B1	7 x 4.0 x 75
	TX84575B1	8 x 4.5 x 75
	TX94575B1	9 x 4.5 x 75
	TX104575B1	10 x 4.5 x 75
	TX154575B1	15 x 4.5 x 75
	TX205075B1	20 x 5.0 x 75
	TX255075B1	25 x 5.0 x 75
	TX275575B1	27 x 5.5 x 75
	TX306075B1	30 x 6.0 x 75
	TX407075B1	40 x 7.0 x 75
	TX458075B1	45 x 8.0 x 75

 TRI-WING		P x L
	TW03050B1	0 x 3 x 50
	TW13050B1	1 x 3 x 50
	TW23050B1	2 x 3 x 50
	TW34050B1	3 x 4 x 50
	TW44050B1	4 x 4 x 50
	TW55050B1	5 x 5 x 50

 TORQ-SET		P x L
	TS03050B1	0 x 3 x 50
	TS13050B1	1 x 3 x 50
	TS23050B1	2 x 3 x 50
	TS34050B1	3 x 4 x 50
	TS44050B1	4 x 4 x 50
	TS55050B1	5 x 5 x 50
	TS65050B1	6 x 5 x 50
	TS86050B1	8 x 6 x 50
	TS106050B1	10 x 6 x 50

 TRIANGLE		T x L
	TA1850B1	TA18 x 50
	TA2050B1	TA20 x 50
	TA2350B1	TA23 x 50
	TA2750B1	TA27 x 50

 SPANNER		T x L
	SP4550B1	4.5 x 50
	SP5050B1	5 x 50
	SP6050B1	6 x 50

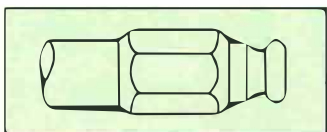

OTHER LENGTHS OR TYPES AVAILABLE ON REQUEST.

特殊起子頭



5/16" = 8mm DESOUTTER HEX DRIVE

● FOR: BRIDGES, BUCKEY-TOOLS, DEMAG(FMA), DESOUTTER, FIAM, GRASSO, OBER, RURES, SUHNER

PHILLIPS	Model No.	P x D x L
	PH16452D8	1 x 6.4 x 52
	PH26452D8	2 x 6.4 x 52
	PH37752D8	3 x 6.4 x 52
POZIDRIV	Model No.	P x D x L
	PZ16452D8	1 x 6.4 (52mm)
	PZ26452D8	2 x 6.4 (52mm)
	PZ37752D87	3 x 7.7 (52mm)

LENGTH FOR 32mm AND 92mm AVAILABLE

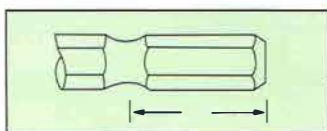

FASTENING BOLTS & NUTS US-4特製套筒 5mm HEX DRIVE

● FOR: DELVO (DENSEI), HIOS (FERRA TOOLS), HITACHI, MATSUSHITA, URYU, YOKOTA

METRIC (NON MAGNETIC)	Model No.	A/F x L
	SH52550	5 x 25 x 50
	SH5.53055	5.5 x 30 x 55
	SH63560	6 x 35 x 60
	SH74065	7 x 40 x 65
	SH85075	8 x 50 x 75
	SH96085	9 x 60 x 85
	SH107095	10 x 70 x 95
	SH1180105	11 x 80 x 105
	SH1290115	12 x 90 x 115
	SH13100125	13 x 100 x 125

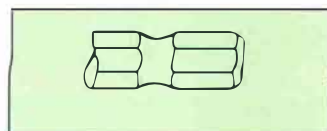

ADAPTER FOR SOCKETS US-5長柄套筒 1/4" = 6.35mm HEX DRIVE

MALE SQUARE	Model No.	A/F x D x L
	SHW52560	5 x 25 x 60
	SHW5.52565	5.5 x 25 x 65
	SHW62570	6 x 25 x 70
	SHW72575	7 x 25 x 75
	SHW82580	8 x 25 x 80
	SHW92590	9 x 25 x 90
	SHW1025100	10 x 25 x 100
	SHW1025110	11 x 25 x 110
	SHW1225120	12 x 25 x 120
	SHW1325125	13 x 25 x 125

Changes the sleeve

OTHER LENGTHS OR TYPES AVAILABLE ON REQUEST.

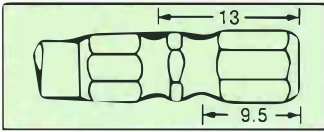

US-5對邊6.35mm各式套筒

1/4" = 6.35mm HEX DRIV

- FOR: AEROMAX, AET, ARO, ATLAS-COPCO, BIAx, B & D, BOSCH, BUCKEYE-TOOLS, CHICAGO-PNEUMATIC, CLECO, DELCO, DELVO (DENSEI), DEPRAG, DESOUTTER, FIAM, FUJI-KUKI, GARDNER-DENVER, HIOS (FERRA TOOLS), HITACHI, INGERSOLL, KELLER, MAKITA, MALL, MATSUSHITA, METABO, NPK, PNEUTEC, PREMAG, ROCKWELL, ROTOR-TOOL, SKIL, STANLEY, STAR, STAYER, THOR, TONICHI, URYU, VAN-DORN, VIRAX, WOLF, YOKOTA, YUTANI, JOHN LEE

METRIC (NON MAGNETIC)	Model No.	A/F x D x d x L
	SN501555F3	5 x 8.5 x 15 x 55
	SN551555F3	5.5 x 9 x 15 x 55
	SN601555F3	6 x 10 x 15 x 55
	SN701555F3	7 x 13 x 15 x 55
	SN801555F3	8 x 13 x 15 x 55
	SN901555F3	9 x 14 x 15 x 55
	SN1001555F3	10 x 16 x 15 x 55
	SN1101555F3	11 x 17 x 15 x 55
	SN1201555F3	12 x 19 x 15 x 55
	SN1301555F3	13 x 19 x 15 x 55
	SN1401555F3	14 x 20 x 15 x 55
	SN631165F3	1/4 x 7/16 x 2-9/16"
	SN791265F3	5/16 x 1/2 x 2-9/16"
	SN951465F3	3/8 x 9/16 x 2-9/16"
	SN111565F3	7/16 x 5/8 x 2-9/16"
	SN502565F3	5 x 8.5 x 25 x 65
	SN552565F3	5.5 x 9 x 25 x 65
	SN602565F3	6 x 10 x 25 x 65
	SN702565F3	7 x 13 x 25 x 6
	SN803065F3	8 x 13 x 30 x 65
	SN903065F3	9 x 14 x 30 x 65
	SN1003065F3	10 x 16 x 30 x 65
	SN1103065F3	11 x 17 x 30 x 65
	SN1203065F3	12 x 18 x 30 x 65
	SN1303065F3	13 x 19 x 30 x 65
	SN1403065F3	14 x 20 x 30 x 65
	SN5025100F3	5 x 8.5 x 25 x 100
	SN5525100F3	5.5 x 9 x 25 x 100
	SN6025100F3	6 x 10 x 25 x 100
	SN7025100F3	7 x 13 x 25 x 100
	SN8030100F3	8 x 13 x 30 x 100
	SN9030100F3	9 x 14 x 30 x 100
	SN10030100F3	10 x 16 x 30 x 100
	SN11030100F3	11 x 17 x 30 x 100
	SN12030100F3	12 x 18 x 30 x 100
	SN13030100F3	13 x 19 x 30 x 100
	SN14030100F3	14 x 20 x 30 x 100

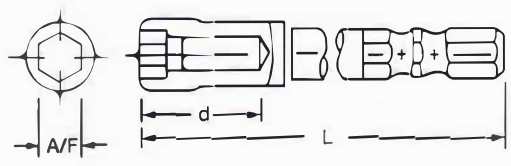

MAGNETIC TYPE (SN → SM) AVAILABLE ON REQUEST

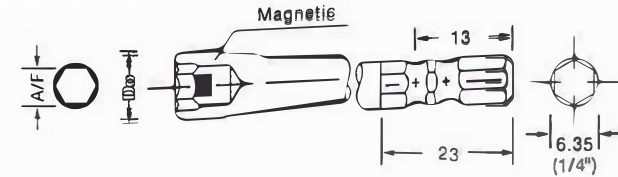

OTHER LENGTHS OR TYPES AVAILABLE ON REQUEST.